



New York City College of Technology

Theatreworks- The Gravesend Inn

Topsy's Parlor

Renderings- DS Wall and SL Wall Removed

Date: 11/28/15

Rev:

Scale:

NTS

Plate

1

Notes:

Drawn By: Will Griffith

Of 11



New York City College of Technology

Theatreworks- The Gravesend Inn

Tipsy's Parlor

Renderings- US Wall and SR Wall Removed

Date: 11/28/15

Rev:

Scale:

NTS

Plate

2

Notes:

Drawn By: Will Griffith

Of 11

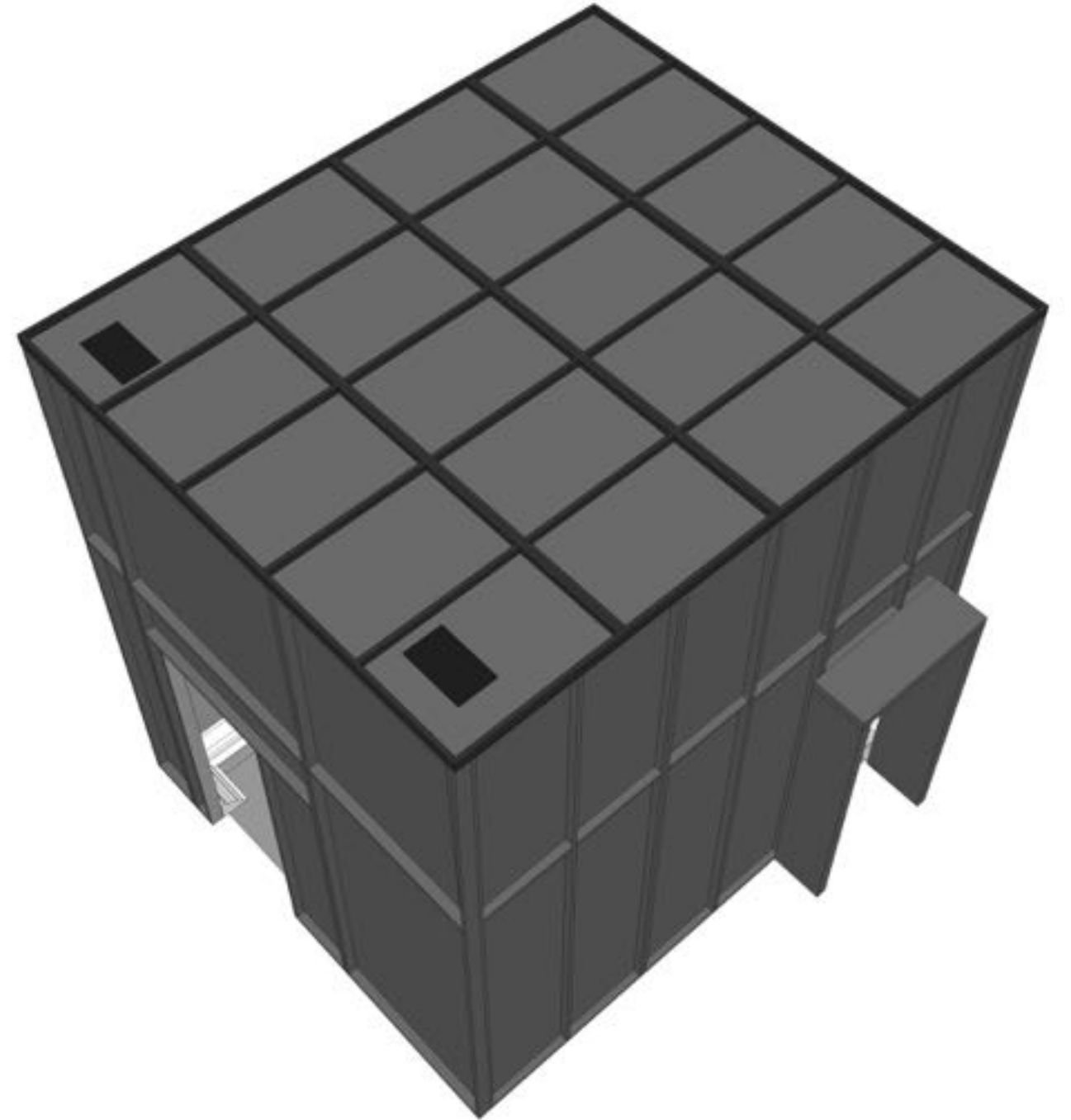

New York City College of Technology

Theatreworks- The Gravesend Inn

Tipsy's Parlor

Renderings- DS Wall and Full Room

Date: 11/28/15

Rev:

Scale:

NTS

Plate

3

Notes:

Drawn By: Will Griffith

Of 11

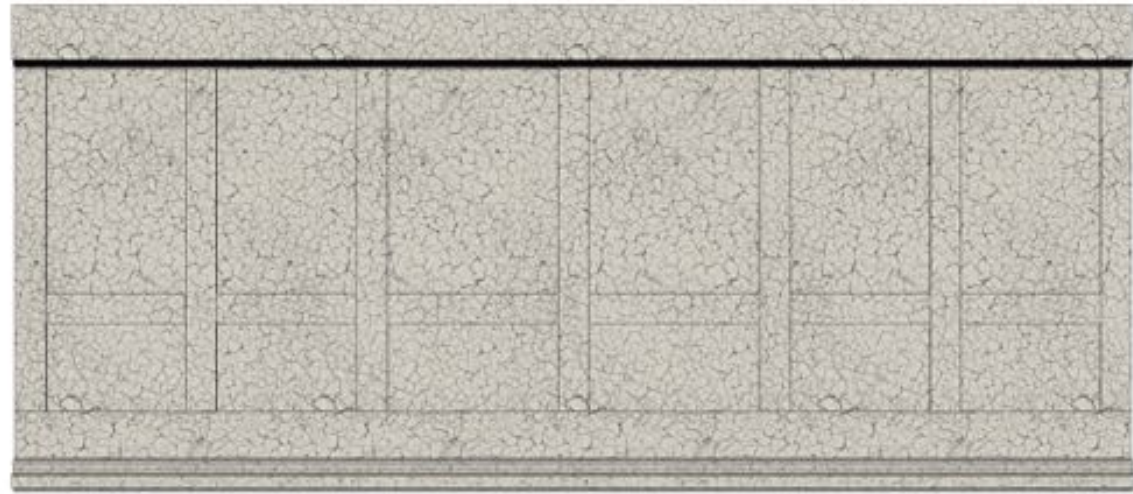

Chandelier (or similar)

Library table (or similar)



Wainscoting Texture



Plaster texture for lower parts of wall



Lath texture for "broken wall" sections



New York City College of Technology

Date: 11/28/15

Rev:

Scale:

Plate

Theatreworks- The Gravesend Inn

Tipsy's Parlor

Paint and Prop Details

NTS

4

Notes:

Drawn By: Will Griffith

Of 11

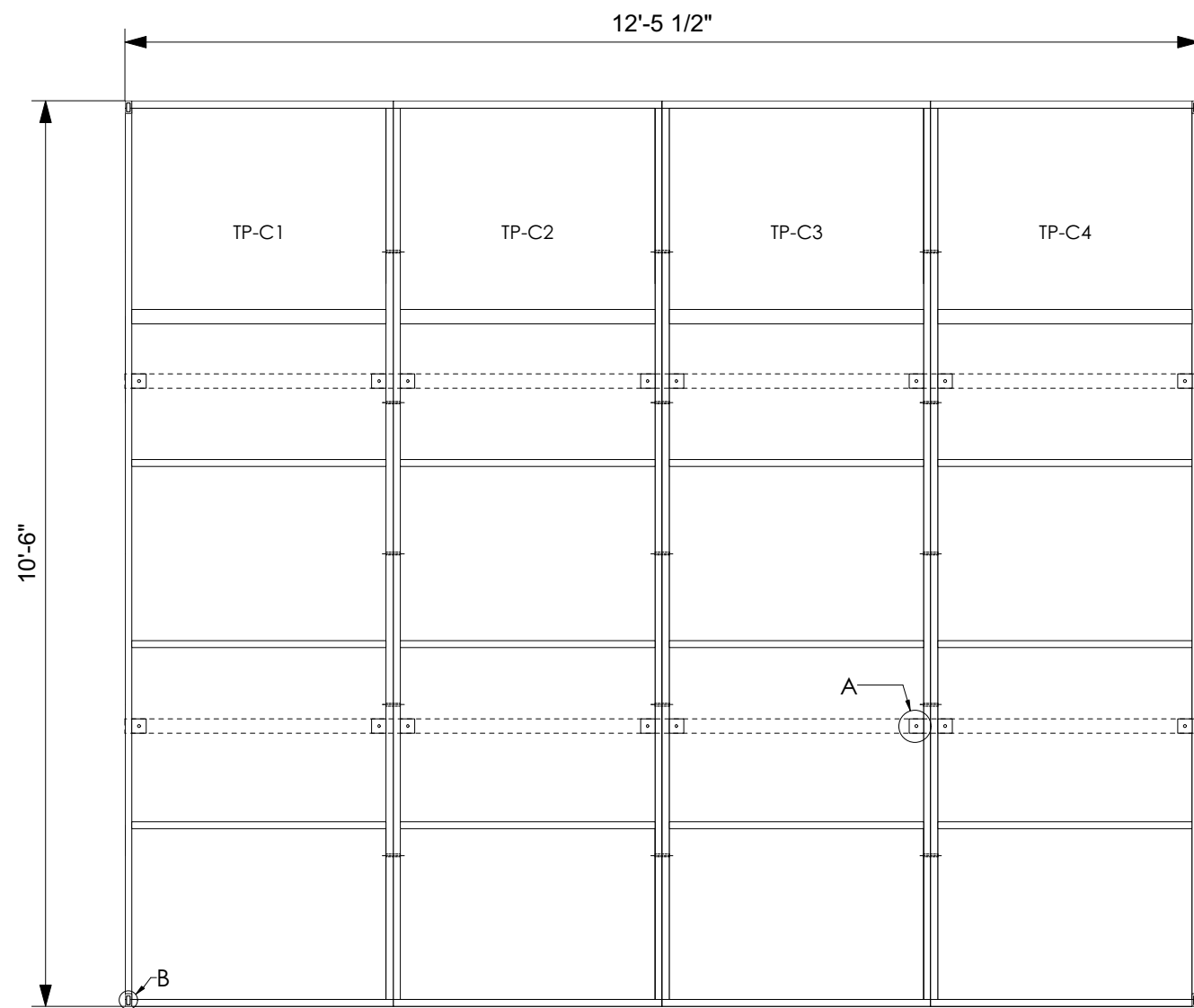

Ceiling
Top View
See Next Plate for Construction Information

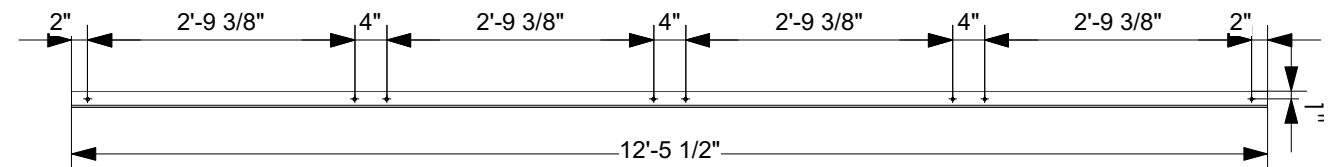

Ceiling Supports
2x2 Angle
Drill 7/16\"/>

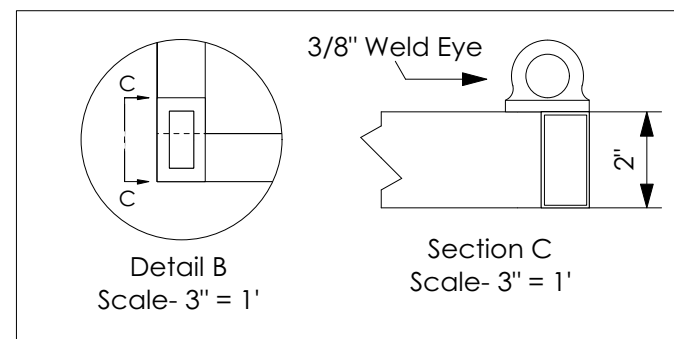
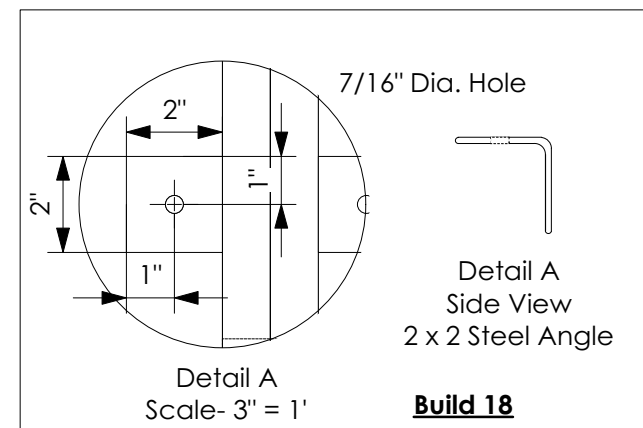

New York City College of Technology

Theatreworks- The Gravesend Inn

Tipsy's Parlor

Ceiling Overview

Date: 11/28/15

Rev:

Scale:

1/2" = 1'

Plate

5

Notes:

Drawn By: Will Griffith

Of 11

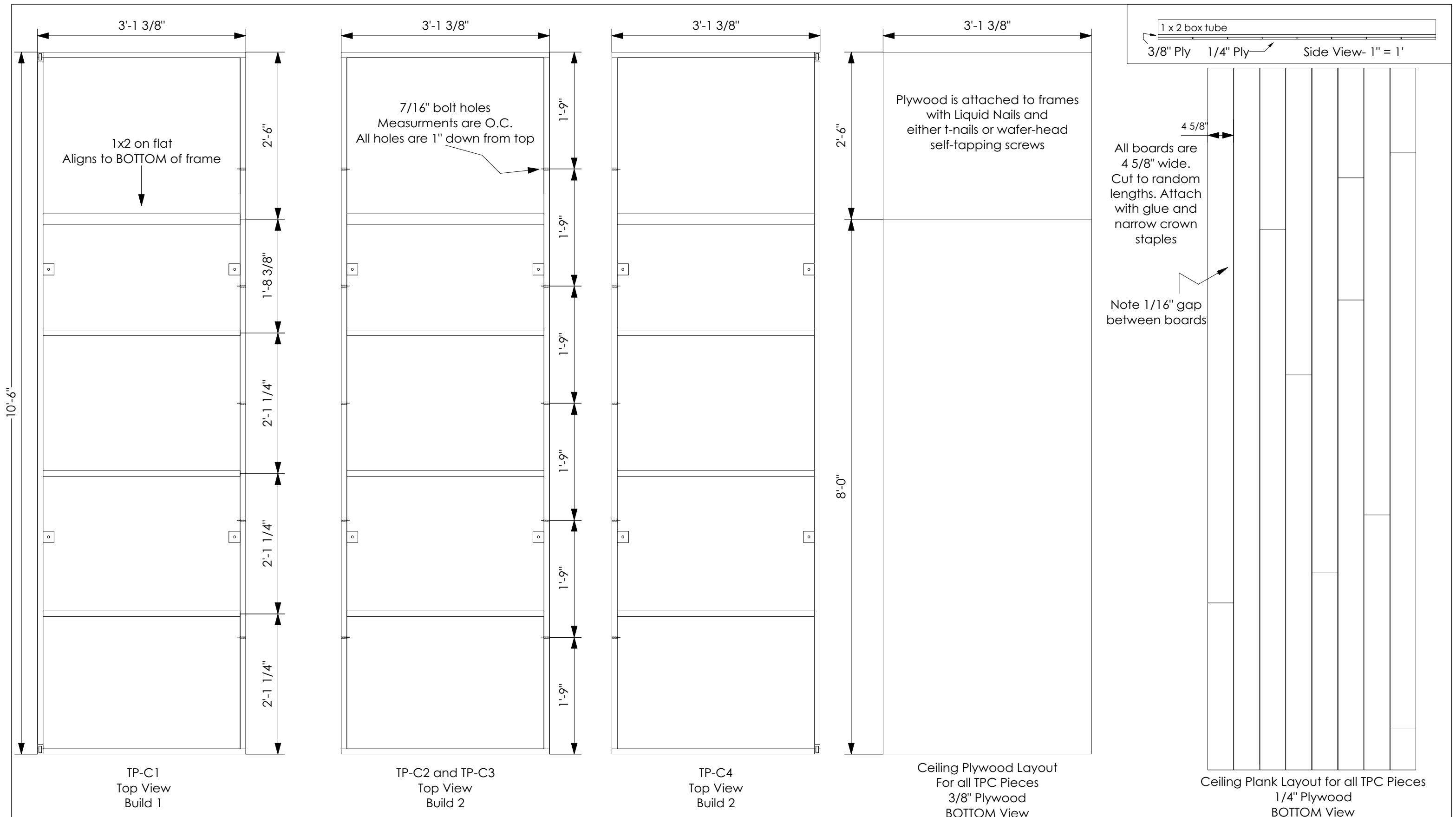

New York City College of Technology

Theatreworks- The Gravesend Inn

Tipsy's Parlor

Ceiling Panel Details

Date: 11/28/15

Rev:

Scale:
1/2" = 1'

Plate
6
Of 11

Notes:

Drawn By: Will Griffith

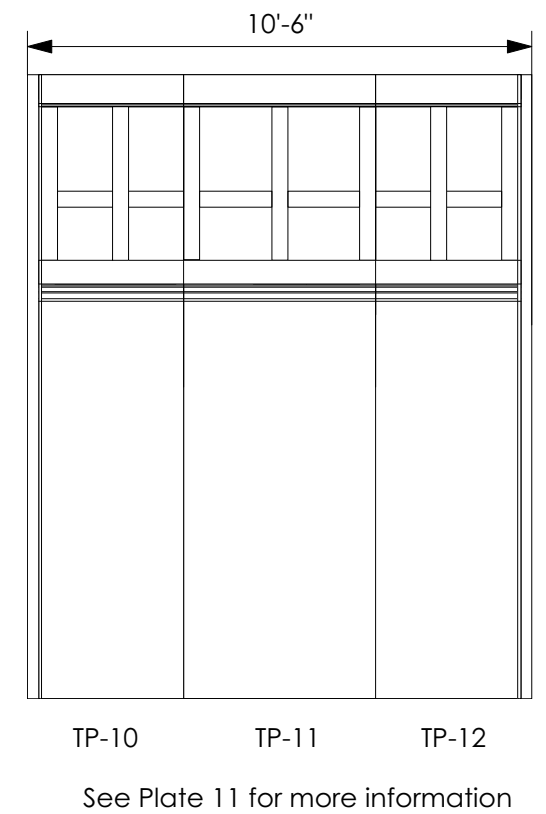
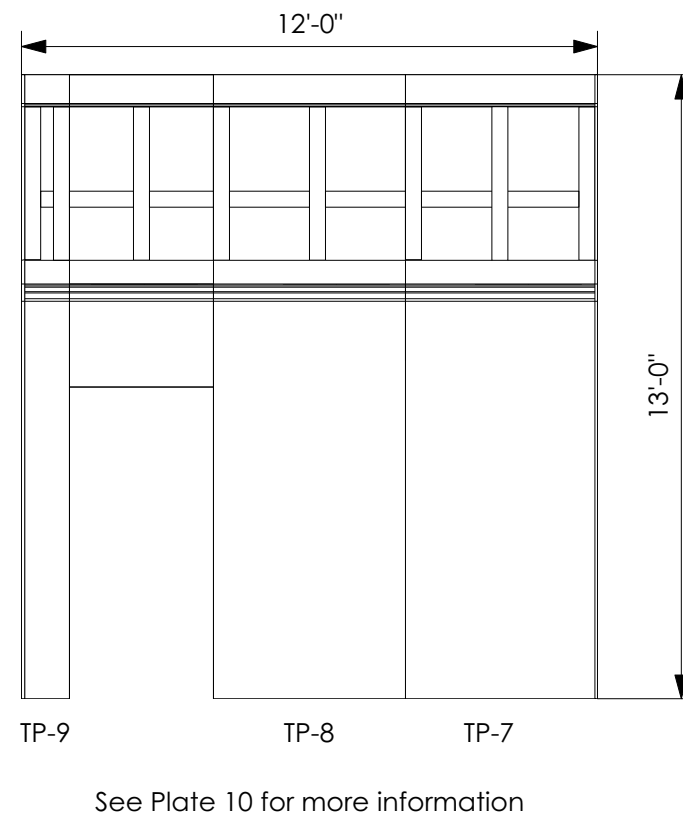
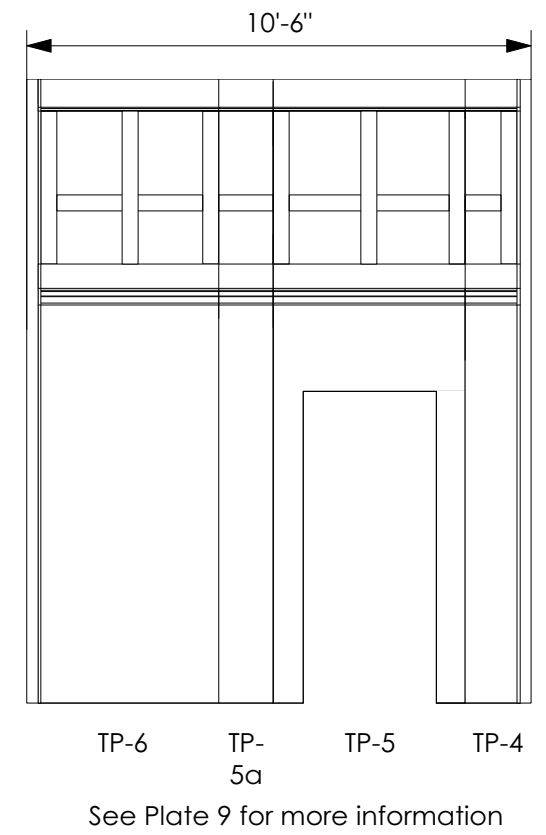
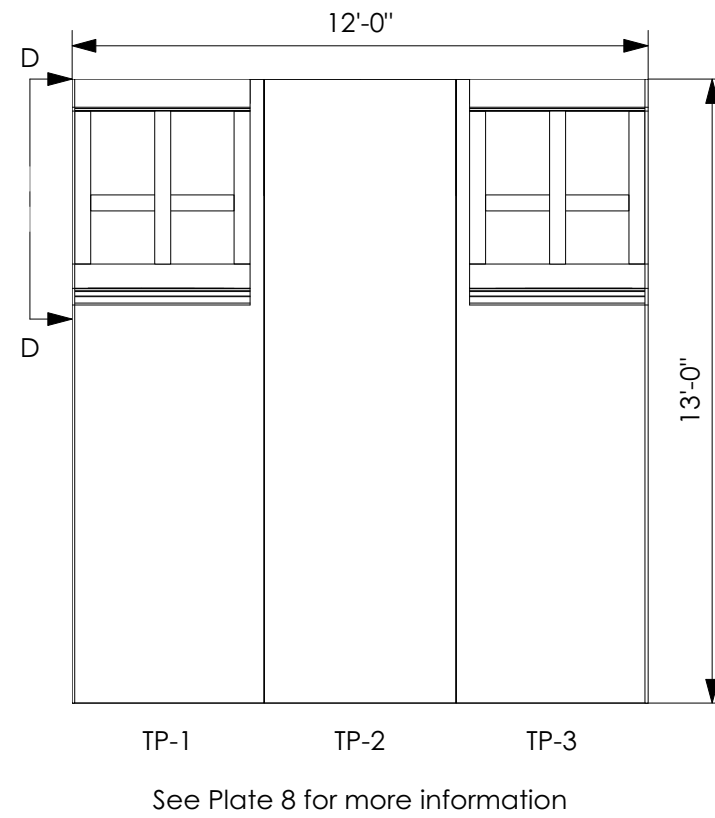
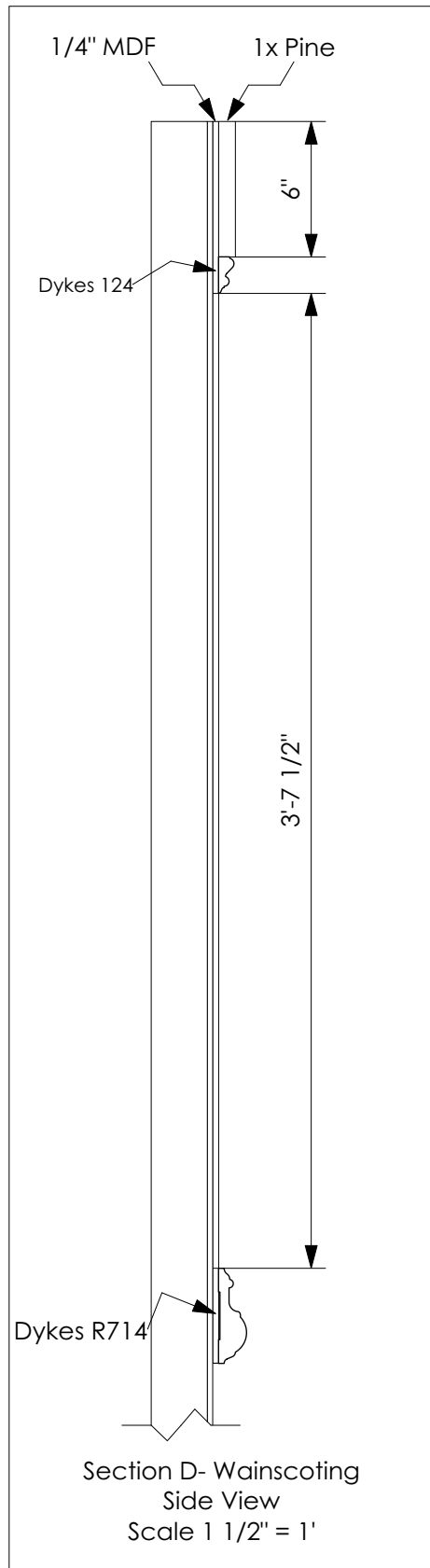
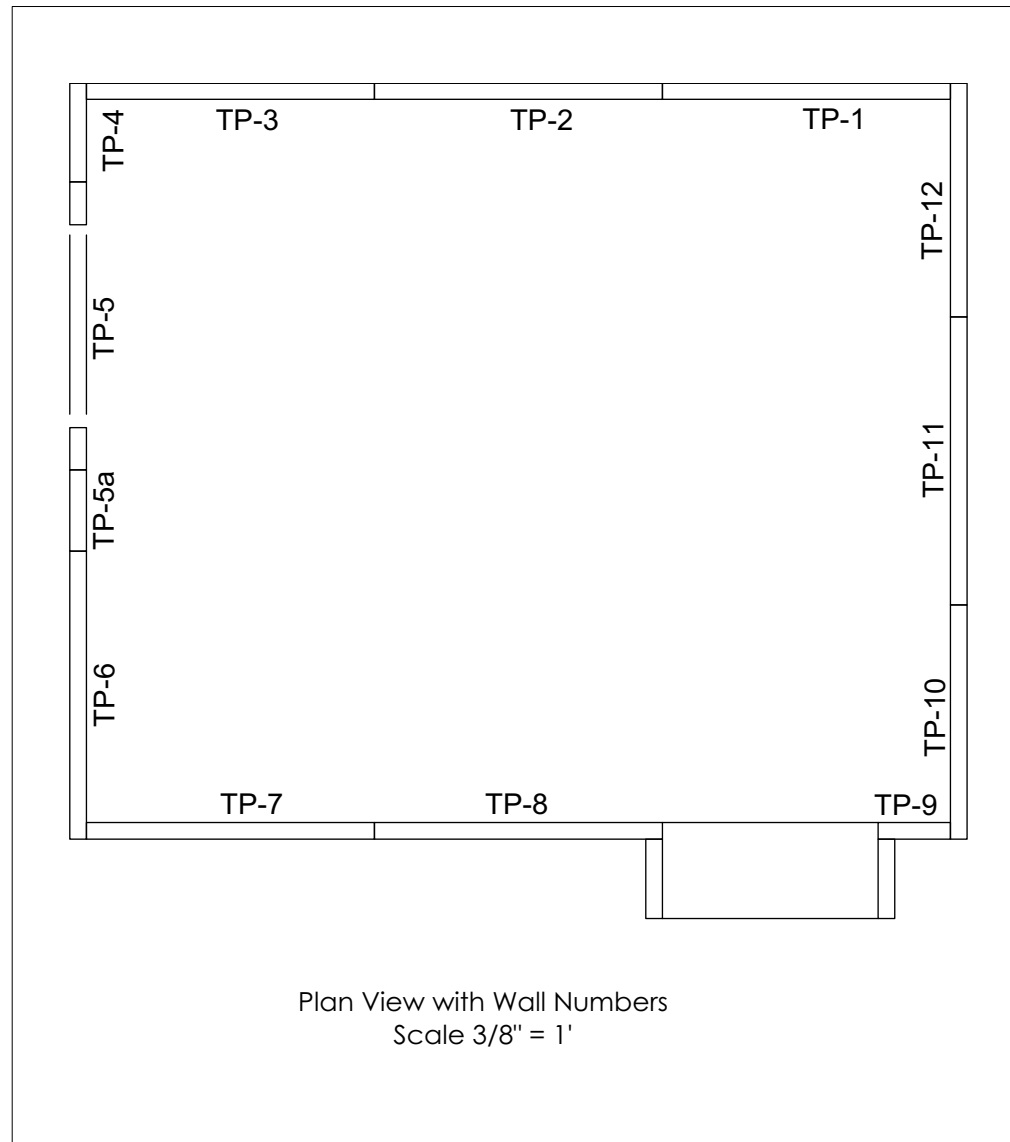

New York City College of Technology

Theatreworks- The Gravesend Inn

Tipsy's Parlor

Tipsy Walls and Wainscoting

Date: 11/28/15

Rev:

Scale:
1/4" = 1'

Plate
7
Of 11

Notes:

Drawn By: Will Griffith

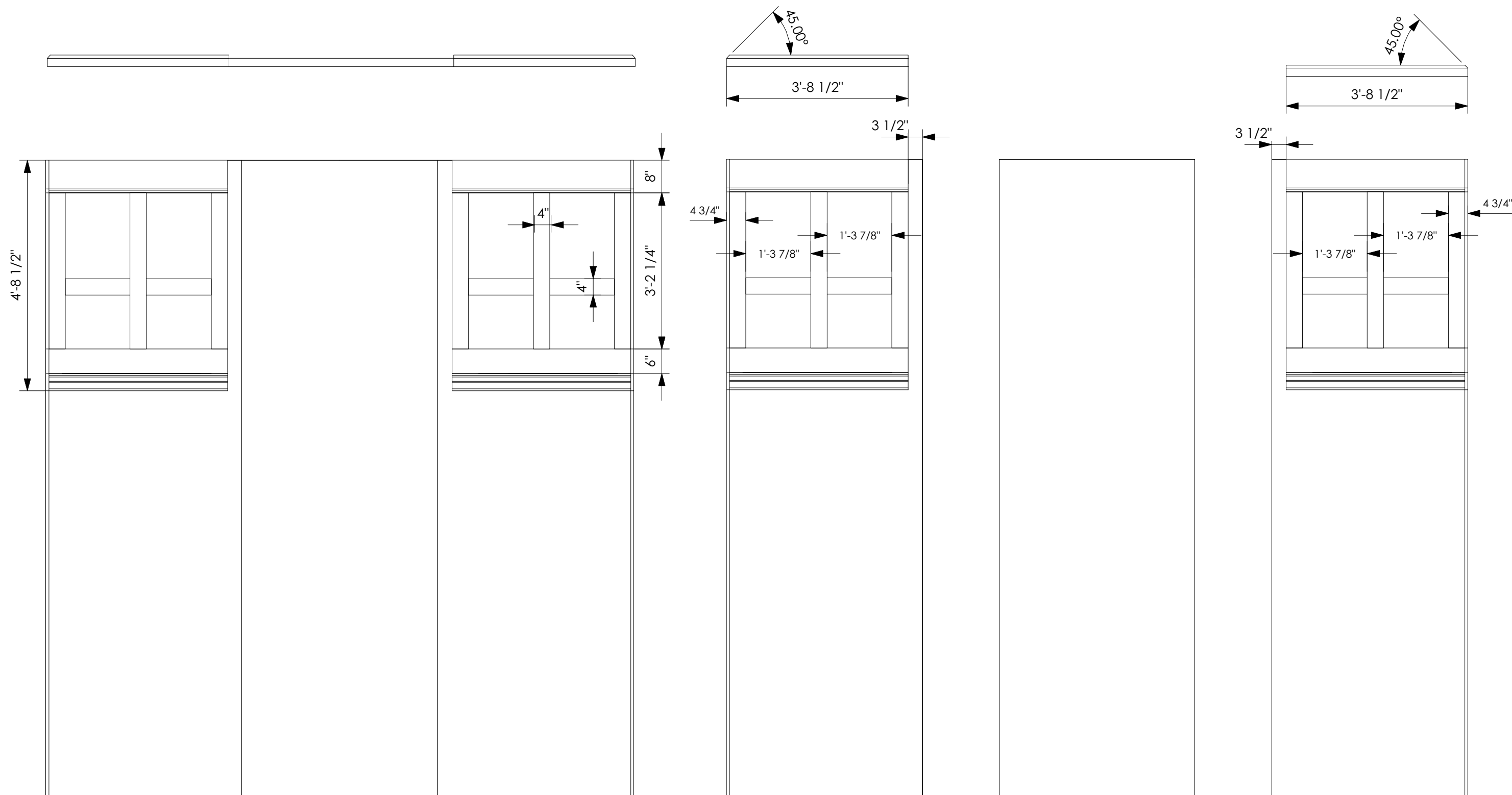

TP-3

TP-2

TP-1

TP-3

TP-2

TP-1



New York City College of Technology

Theatreworks- The Gravesend Inn

Tipsy's Parlor

TP 1, 2, & 3- US Wall

Date: 11/28/15

Rev:

Scale:
1/2" = 1'

Plate
8
Of 11

Notes:

Drawn By: Will Griffith

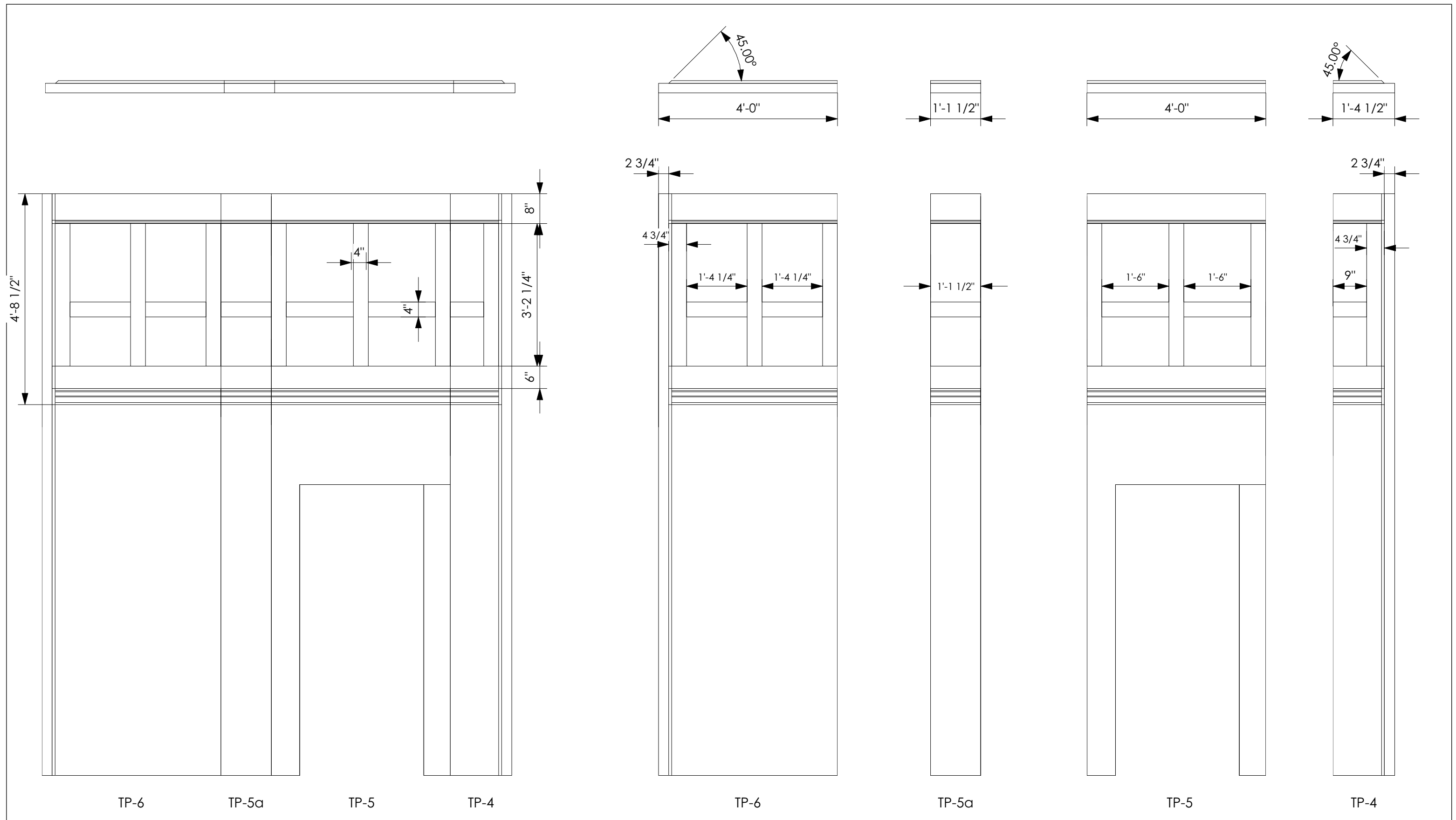

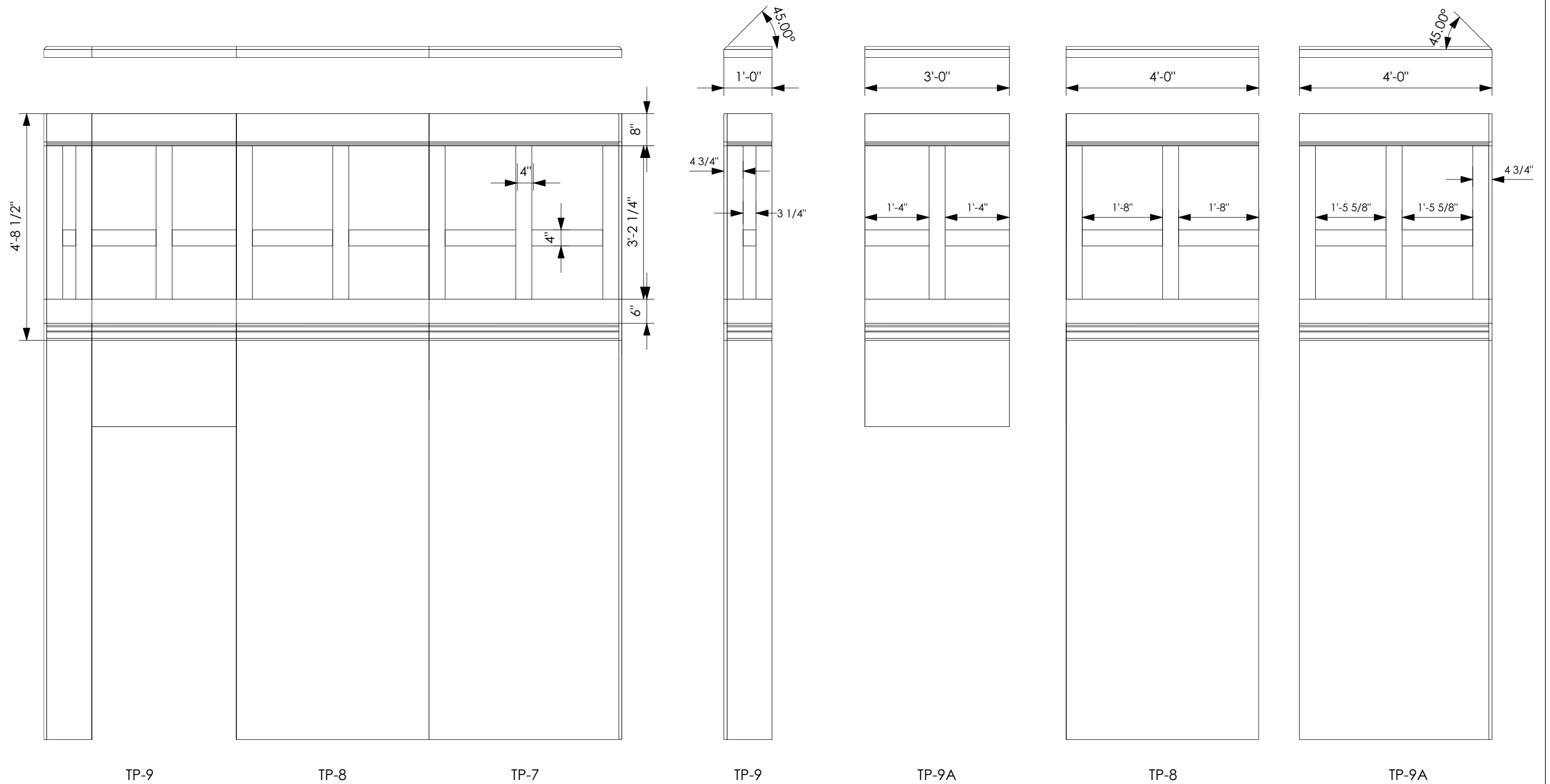

TP-9

TP-8

TP-7

TP-9

TP-9A

TP-8

TP-9A



New York City College of Technology

Theatreworks- The Gravesend Inn

Tipsy's Parlor

TP 7, 8, & 9- DS Wall

Date: 11/28/15

Rev:

Scale:
1/2" = 1'

Plate
10
Of 11

Notes:

Drawn By: Will Griffith

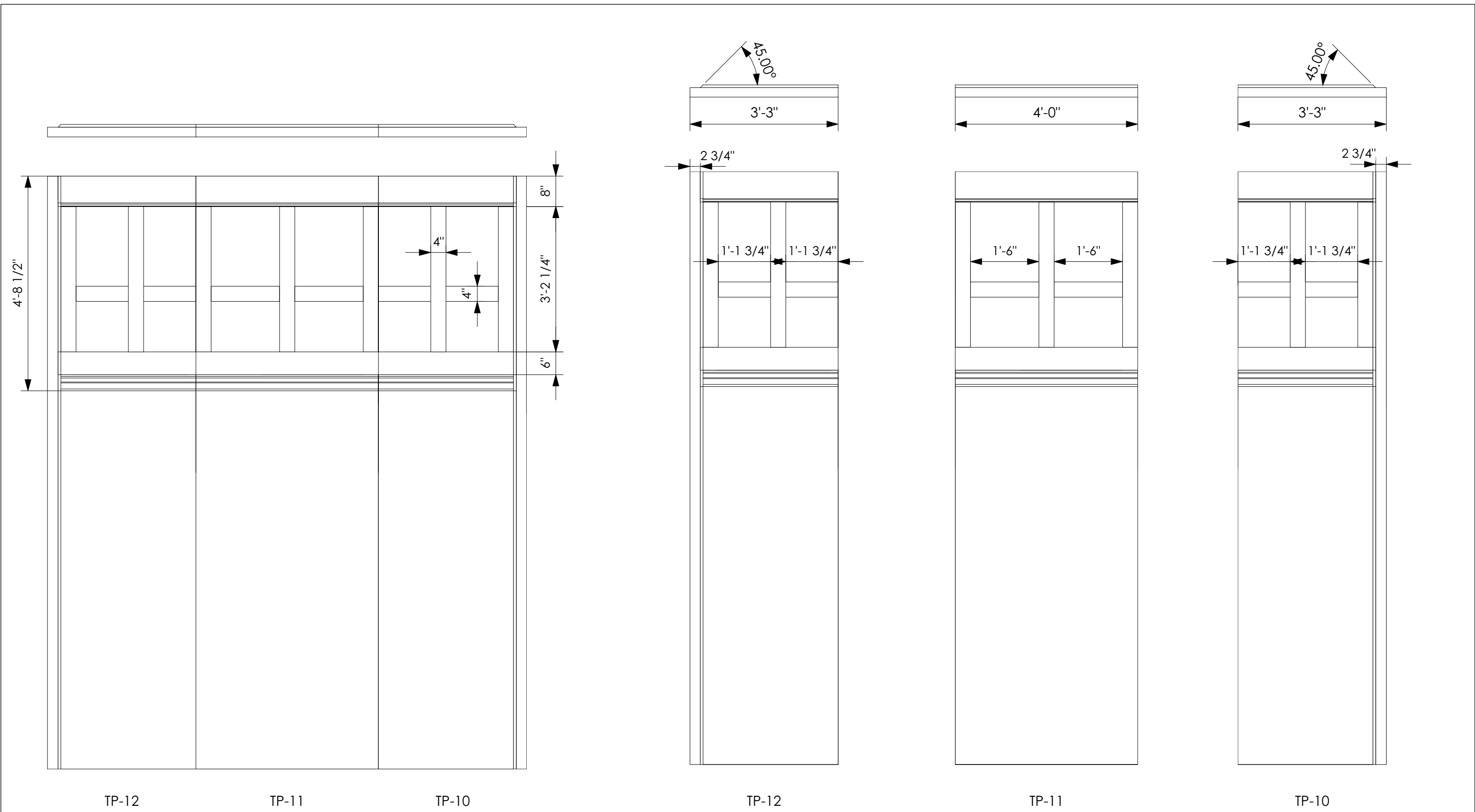

TP-12

TP-11

TP-10

TP-12

TP-11

TP-10



New York City College of Technology

Date: 11/28/15

Rev:

Scale:
1/2" = 1'

Plate
11
Of 11

Theatreworks- The Gravesend Inn

Tipsy's Parlor

TP 10, 11, & 12- SL Wall

Notes:

Drawn By: Will Griffith